Foundry AR-Series Rack-Mounted Router Quick Installation Guide



2100 Gold Street
P.O. Box 649100
San Jose, CA 95164-9100
Tel 408.586.1700
Fax 408.586.1900

June 2004

Copyright © 2004 Foundry Networks, Inc. All rights reserved.

No part of this work may be reproduced in any form or by any means – graphic, electronic or mechanical, including photocopying, recording, taping or storage in an information retrieval system – without prior written permission of the copyright owner.

The trademarks, logos and service marks (“Marks”) displayed herein are the property of Foundry or other third parties. You are not permitted to use these Marks without the prior written consent of Foundry or such appropriate third party.

Foundry Networks, BigIron, FastIron, IronView, JetCore, NetIron, ServerIron, Turbolron, IronWare, EdgIron, IronPoint, AccessIron, the Iron family of marks and the Foundry Logo are trademarks or registered trademarks of Foundry Networks, Inc. in the United States and other countries.

F-Secure is a trademark of F-Secure Corporation. All other trademarks mentioned in this document are the property of their respective owners.

CHAPTER 1

GETTING STARTED.....	1-1
INTRODUCTION	1-1
AUDIENCE	1-1
NOMENCLATURE	1-1
RELATED PUBLICATIONS	1-2
LIST OF FEATURES	1-2
HOW TO GET HELP	1-5
WEB ACCESS	1-5
EMAIL ACCESS	1-5
TELEPHONE ACCESS	1-5
WARRANTY COVERAGE	1-5

CHAPTER 2

INSTALLING AND CONFIGURING RACK-MOUNTED SYSTEMS.....	2-1
BEFORE YOU BEGIN	2-1
UNPACKING AND INSPECTING	2-1
ADDITIONAL CABLES, TOOLS, AND MATERIALS	2-1
INSTALLATION SITE	2-2
PORTS AND CONNECTIONS	2-2
DIAL-OUT PORTS	2-4
CONSOLE CABLE	2-4
ETHERNET, E1, T1, CT3, CLEAR CHANNEL DS3, AND USSI	2-4
ALARMS	2-5
POWER	2-5
MANAGEMENT INTERFACE	2-5
INITIAL CONFIGURATION	2-5
INTERFACE CONFIGURATION	2-6
T1 INTERFACE	2-7
E1 INTERFACE	2-7

BUNDLE CONFIGURATION	2-7
FRACTIONAL T1/CISCO-COMPATIBLE HDLC BUNDLE	2-8
T1OR E1/PPP BUNDLE	2-8
ROUTING CONFIGURATION	2-8
RIP	2-8
OSPF	2-8
BGP4	2-9
NxE1/MFR BUNDLE	2-10
FRACTIONAL E1/CISCO-COMPATIBLE HDLC BUNDLE	2-10
SAVING CONFIGURATIONS	2-10
LEDs	2-11

Chapter 1

Getting Started

Introduction

This guide describes how to install and configure a rack-mounted AR1208-T, AR1208-E, AR1216-T, AR1216-E, AR3201-T-CL, AR3202-T-CL, AR3201-T-CH, and AR3202-T-CH router.

Audience

This manual is designed for system administrators with a working knowledge of Layer 2 and Layer 3 switching and routing.

If you are using a Foundry Layer 3 Switch, you should be familiar with the following protocols if applicable to your network – IP, RIP, OSPF, BGP4, IGMP, PIM, and VRRP.

Nomenclature

This guide uses the following typographical conventions to show information:

Italic highlights the title of another publication and occasionally emphasizes a word or phrase.

Bold highlights a CLI command.

Bold Italic highlights a term that is being defined.

Underline highlights a link on the Web management interface.

Capitals highlights field names and buttons that appear in the Web management interface.

NOTE: A note emphasizes an important fact or calls your attention to a dependency.

WARNING: A warning calls your attention to a possible hazard that can cause injury or death.

CAUTION: A caution calls your attention to a possible hazard that can damage equipment.

Related Publications

The following Foundry Networks documents supplement the information in this guide.

- **Release Notes**
Printed release notes provide the latest information. If release notes are provided with your product, follow the instructions contained within them instead of those provided in other documentation.
- *Foundry AR-Series Rack-Mounted Router Installation Guide*
This detailed guide provides detailed installation and configuration steps for installing Foundry AccessIron rack-mounted routers.
- *Foundry AR-Series Router Configurations Guide*
This guide provides examples of AccessIron configurations.
- *Foundry AR-Series Router Command Reference Guide*
This guide explains the syntax and application of AccessIron router CLI commands.
- *Foundry AR-Series Router User Guide*
This guide explains the AccessIron router features.

To order additional copies of these manuals, do one of the following:

- Call 1.877.TURBOCALL (887.2622) in the United States or 1.408.586.1881 outside the United States.
- Send email to info@foundrynet.com.

List of Features

June 2004 Table 1.1 shows the features supported on AccessIron devices.

Table 1.1: Feature Supported in AccessIron Devices

Category	Feature	AR1202 AR1204 AR1208 AR1216	AR3201-T-CL AR3202-T-CL	AR3201-T-CH AR3202-T-CH
Interfaces				
WAN/LAN	10/100 Fast Ethernet	2	2	2
	T1/E1	Yes	-	-
	Channelized T3	-	-	Yes
	Clear Channel T3	-	Yes	-
WAN Protocols				
PPP, PAP, Multilink PPP, Frame Relay, Multilink Frame Relay, (FRF.15, FRF.16.1) BCP, HDLC				
Layer 2 Features				
	802.1Q VLAN tagging and forwarding over WLAN			
	Virtual LAN Domain (VLD) VLAN Double Tagging			
	Transparent Bridging			
	Jumbo Frames (4072 bytes)			

Table 1.1: Feature Supported in AccessIron Devices (Continued)

Category	Feature	AR1202 AR1204 AR1208 AR1216	AR3201-T-CL AR3202-T-CL	AR3201-T-CH AR3202-T-CH
	IP Multiplexing			
	NAT mode			
	Transparent Layer 3 packet forwarding			
Layer 3 Features				
Routing	RIPv1/v2			
	OSPF			
	BGP4			
	Static Routing			
	ECMP (IP load balancing)			
	Multicast (PIM-SM, PIM-SSM, IGMP v2/v3)			
High Availability	VRRP			
	BGP4 Multi-homing			
	Bundle Tracking			
	MLPPP Bundle Thresholding			
	LAN Interface Load Sharing with Failover			
Security/ Management	Stateful Packet Inspection Firewall with: <ul style="list-style-type: none"> Layer-3 mode (router and NAT) Policy-based NAT/PAT Policy-based filters URL and application content filtering Time and rate limiting Denial of Service protection Network attack detection Application Level Gateway support Packet-level logging and syslog support 			

Table 1.1: Feature Supported in AccessIron Devices (Continued)

Category	Feature	AR1202 AR1204 AR1208 AR1216	AR3201-T-CL AR3202-T-CL	AR3201-T-CH AR3202-T-CH
	ACLs			
	DHCP			
	TFTP			
	PAP			
	RADIUS			
	TACACS+			
	SSH v2			
	GRE Tunneling			
	IPSec VPN with integrated IKE Site-to-site VPN Site-to-remote VPN MD5 & SHA-1 authentication Hardware accelerated encryption 3DES (168 bit), DES (56 bit), AES (256 bit) encryption	VPN optional on the AR1202 and AR1204	-	-
QoS/Traffic Management	RED			
	DiffServ			
	Class-based Queuing per: IP address Flow VLAN tag Application port			
	Frame Relay traffic shaping and policing			
	VLAN-802.1P 8 queue prioritization of VLAN frames			
Service Provisioning	Management (in-band, serial, Telnet, or modem) by: CLI SNMP			
	Monitoring syslog Statistics Alarms			
	Diagnostics BERT Loopback testing Traceroute Reverse Telnet			
Specialized Features	Hospitality Web Redirection			

Table 1.1: Feature Supported in AccessIron Devices (Continued)

Category	Feature	AR1202 AR1204 AR1208 AR1216	AR3201-T-CL AR3202-T-CL	AR3201-T-CH AR3202-T-CH
	Timed Access List			

How to Get Help

Foundry Networks technical support will ensure that the fast and easy access that you have come to expect from your Foundry Networks products will be maintained.

Web Access

- <http://www.foundrynetworks.com>

Email Access

Technical requests can also be sent to the following email address:

- support@foundrynet.com

Telephone Access

- 1.877.TURBOCALL (887.2622) United States
- 1.408.586.1881 Outside the United States

Warranty Coverage

Contact Foundry Networks using any of the methods listed above for information about the standard and extended warranties.

Chapter 2

Installing and Configuring Rack-Mounted Systems

Before You Begin

Unpacking and Inspecting

The following items are shipped with these systems.

- | | |
|---|--|
| <input type="checkbox"/> Foundry system | <input type="checkbox"/> Two 19-inch (48.26 cm) rack-mount brackets |
| <input type="checkbox"/> AC power cord | <input type="checkbox"/> Two 23-inch (58.42 cm) rack-mount brackets |
| <input type="checkbox"/> RJ-45 console cable | <input type="checkbox"/> Four #6 screws |
| <input type="checkbox"/> Male DB-9 modular adapter | <input type="checkbox"/> Four each #6 flat washers and #6 lock washers |
| <input type="checkbox"/> Female DB-9 modular adapter | <input type="checkbox"/> <i>Product Documentation</i> CD-ROM |
| <input type="checkbox"/> Four self-adhering rubber feet | <input type="checkbox"/> Registration card |
| <input type="checkbox"/> Quick start guide | <input type="checkbox"/> Warranty form |

If any of the above items are missing or defective, contact Foundry.

Additional Cables, Tools, and Materials

The following additional cables are required for integrating these systems with other networking devices.

- RJ-45, male/male, Category 5, shielded, twisted pair cable (Ethernet ports)
- RJ-48C, male/male, shielded, straight-through cable (T1/E1 ports)
- RG-59 coaxial cables with BNC connectors (Clear Channel DS3 and CT3)

The following tools are required for installation.

- #3 Phillips screwdriver (rackmount)
- #2 Phillips screwdriver (mounting bracket)
- 1/8 inch (3 mm) flat-blade screwdriver (DC power, ground, and external alarm)
- wire stripping tool (DC power and external alarm)

The following additional materials are required for connecting DC power, ground, and external alarms to the Foundry system.

- 18-22 AWG wire (external alarm and ground)
- 18 AWG wire (DC power)

Installation Site

These systems are designed to be installed in a 19- or 23-inch (48.26 or 58.42 cm) rack or on a flat, stable surface with sufficient space to accommodate a 12- x 19-inch (30.48 x 48.26 cm) footprint. The installation site should provide ample room for connecting cables and performing maintenance, and the site should not be subject to extreme temperature shifts. The Foundry system should be located in close proximity to all relevant telecommunication ports and power supplies.

Ports and Connections

The following diagrams and sections identify models and provide information about connecting AC and DC power, network cables, and alarm and ground wires.

AR1208-T

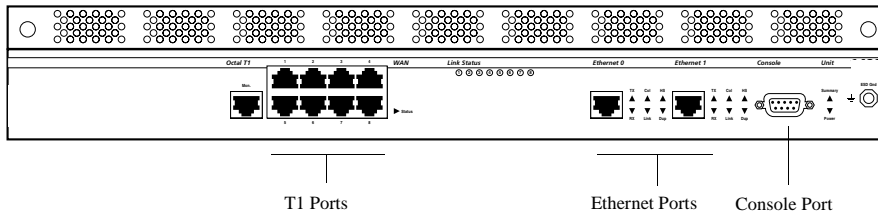

AR1208-E

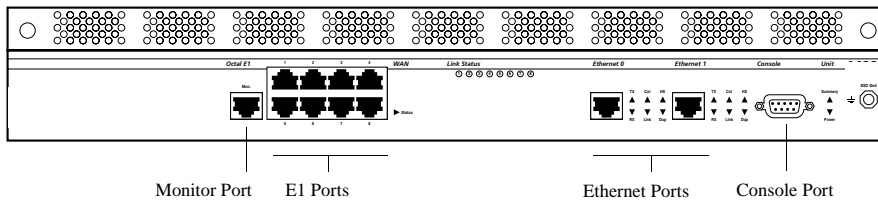

AR1216-T

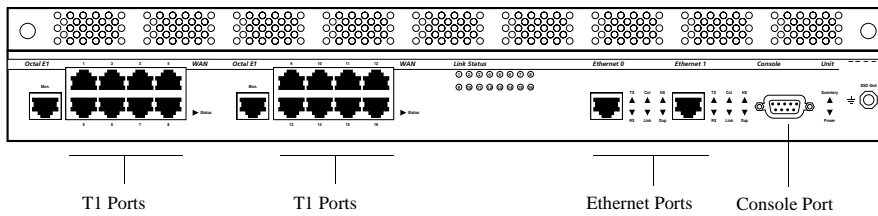

AR1216-E

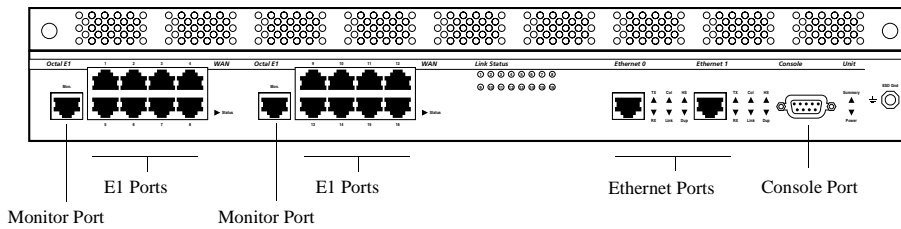

AR3201-T-CH

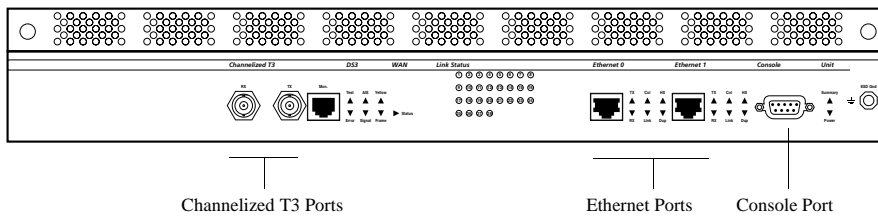

AR3202-T-CH

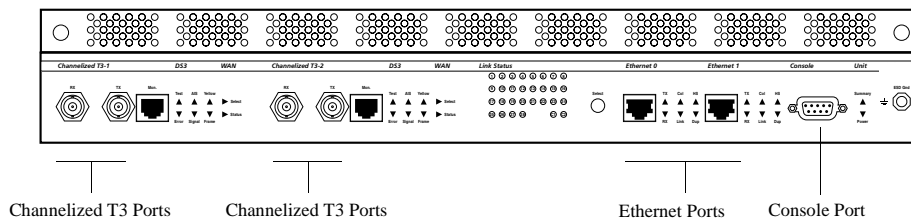

AR3201-T-CL

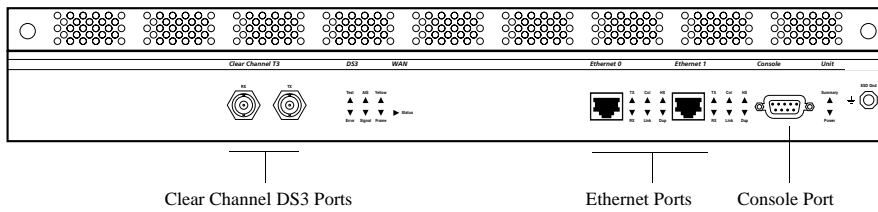

AR3202-T-CL

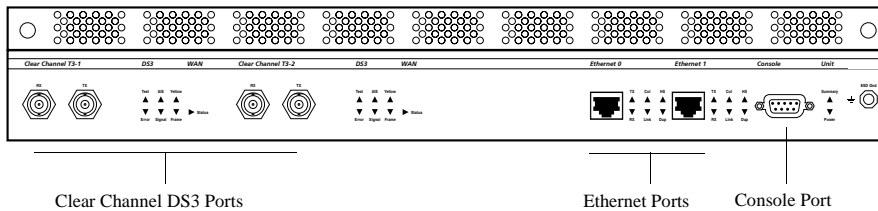

Dial-Out Ports

The AR3202-T-CL, and AR3202-T-CH have a dial-out port on the back panel that is used to notify the network administrator or other designated person about captured system traps. Notification procedures can be set up to meet the needs of the customer via pager or phone message.

Console Cable

Connect the:

- DB-9 modular adapters to the supplied RJ-45 cable
- Male DB-9 modular adapter to the console port
- Female DB-9 modular adapter to a terminal or PC

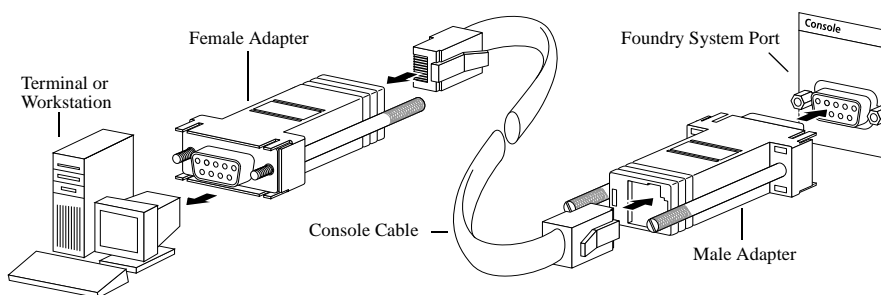

Ethernet, E1, T1, CT3, Clear Channel DS3, and USSI

Connect the:

- RJ-45 connector of an Ethernet cable to the Ethernet 0 or 1 port
- RJ-48C connectors of the T1 cables to the T1/E1 ports (AR1208)

Alarms

Connect the stripped ends of two 18-22 AWG wires to alarm terminals 6 and 7 on the back-panel terminal block.

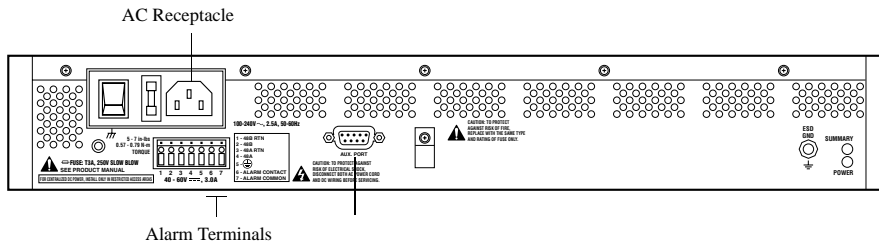

Power

Foundry systems operate on AC, single DC, and dual DC power. For AC power operation, connect the female end of the supplied AC power cord to the AC power receptacle on the system back panel. Connect the male end of the AC cord to a standard 110/120 VAC source. Refer to the figure above. Refer to the *Installation Guide: Domestic Products* for information about dual AC power connection.

To operate with single-source DC power, connect the stripped ends of two 18-AWG wires to either the A or B terminals on the terminal block. Make sure to connect the +48V lead to the appropriate RTN connector.

CAUTION: To avoid equipment damage, make sure that the +48V lead is connected to the appropriate RTN connector (either 1 or 3) on the terminal block.

To operate with dual-source DC power, connect the stripped ends of four 18-AWG wires to the both the A and B terminals on the terminal block. Make sure to connect the +48V leads to the appropriate RTN connectors.

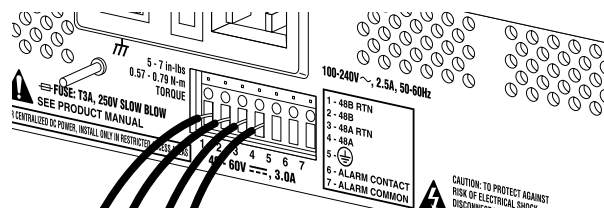

Management Interface

To access the command line interface (CLI) via the front-panel console port, connect a terminal or a workstation running a terminal emulation software to the Foundry system. The software should be configured as follows:

- 9600 bps
- 8 data bits
- 1 stop bit
- No parity
- XON/XOFF flow control

To remotely access the system, configure the modem data port as specified above for terminal emulation software. It is also possible to telnet to the Foundry system once an IP address is assigned to an Ethernet port.

Initial Configuration

Use the following commands to log in as the system administrator, choose a host name, change the password, set the system time, and enter an Ethernet IP address.

Logging In

EXAMPLE:Login: foundry

EXAMPLE:Password: foundry

Choosing a Host Name

EXAMPLE:AR1208# configure term

EXAMPLE:AR1208/configure# hostname ISP_name

Changing the Password

EXAMPLE:AR1208# password

EXAMPLE:name: foundry

EXAMPLE:old password: foundry

EXAMPLE:new password: new_pass

EXAMPLE:re-enter password: new_pass

Passwords are case-sensitive and must be a minimum of three to a maximum of eight characters. Make a note of the password that you use.

Setting the System Date and Time

EXAMPLE:AR1208# configure term

EXAMPLE:AR1208/configure# date - 0 0 mo 3 d 19 y 2000 h 14 mi 40 s 35

The first portion of this command, **date - 0 0**, establishes offset from GMT. The minus sign inputs offset direction, and the two numbers input offset hours and minutes. The second portion of this command, **mo 3 d 19 y 2000 h 14 mi 40 s 35**, inputs the local month, day, year, hour, minute, and second.

Entering an Ethernet IP Address and Subnet Mask

EXAMPLE:AR1208# configure term

EXAMPLE:AR1208/configure# interface ethernet 0

EXAMPLE:AR1208/configure/interface/ethernet 0# ip address 10.1.100.28 255.255.255.0

Interface Configuration

The following are examples of T1, CT3, and DS3 interface configurations. To scroll through the options available at any command prompt, press the Tab key. For descriptions of the options available at any command prompt, type **help** and press Enter.

T1 Interface

```
EXAMPLE:AR1208-T# configure term
EXAMPLE:AR1208-T/configure# module t1 4
EXAMPLE:AR1208-T/configure/module/t1 4# clock_source line
EXAMPLE:AR1208-T/configure/module/t1 4# framing esf
EXAMPLE:AR1208-T/configure/module/t1 4# linecode b8zs
EXAMPLE:AR1208-T/configure/module/t1 4# yellow_alarm gen_det
EXAMPLE:AR1208-T/configure/module/t1 4# exit 3
```

E1 Interface

```
EXAMPLE:AR1208-E# configure term
EXAMPLE:AR1208-E/configure# module e1 4
EXAMPLE:AR1208-E/configure/module/e1 4# clock_source line
EXAMPLE:AR1208-E/configure/module/e1 4# framing crc
EXAMPLE:AR1208-E/configure/module/e1 4# exit 2
EXAMPLE:AR1208-E/configure# cabletype monitor_port 1 twisted_pair
EXAMPLE:AR1208-E/configure# module e1 4
EXAMPLE:AR1208-E/configure/module/e1 4# linecode hdb3
EXAMPLE:AR1208-E/configure/module/e1 4# yellow_alarm gen_det
EXAMPLE:AR1208-E/configure/module/e1 4# exit 3
```

Bundle Configuration

Foundry systems support PPP, MLPPP, FR, MFR, and Cisco-compatible HDLC for WAN data transmission.

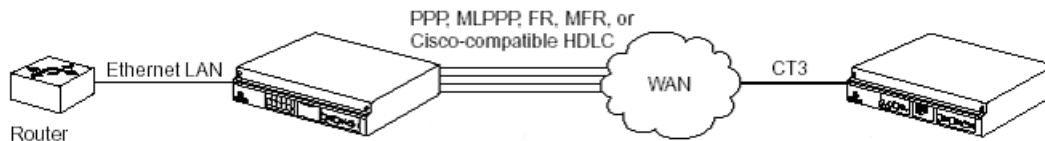

NOTE: Bundle names cannot exceed eight characters.

The following are examples of bundles configured for T1/E1, fractional T1/E1, and NxT1/NxE1 transmission.

Fractional T1/Cisco-compatible HDLC Bundle

```
EXAMPLE:AR1208-T# configure term
EXAMPLE:AR1208-T/configure# interface bundle Denver
EXAMPLE:AR1208-T/configure/interface/bundle Denver# link t1 3:1-6
EXAMPLE:AR1208-T/configure/interface/bundle Denver# encapsulation hdlc
EXAMPLE:AR1208-T/configure/interface/bundle Denver# hdlc keepalive 20
EXAMPLE:AR1208-T/configure/interface/bundle Denver# ip address 192.168.2.1 255.255.255.0
EXAMPLE:AR1208-T/configure/interface/bundle Denver# exit 3
```

T1or E1/PPP Bundle

```
EXAMPLE:AR1208-T# configure term
EXAMPLE:AR1208-T/configure# interface bundle Boston
EXAMPLE:AR1208-T/configure/interface/bundle Boston# link t1 4
EXAMPLE:AR1208-T/configure/interface/bundle Boston# encapsulation ppp
EXAMPLE:AR1208-T/configure/interface/bundle Boston# ip address 199.1.1.1 255.255.255.0
EXAMPLE:AR1208-T/configure/interface/bundle Boston# exit 3
```

Routing Configuration

Foundry products support RIP, OSPF, and BGP4 routing protocols.

RIP

Configuring RIP for Ethernet 0 and WAN 1 interfaces.

```
EXAMPLE:AR1208# configure terminal
EXAMPLE:AR1208/configure# router rip
EXAMPLE:AR1208/configure/router rip# interface ethernet0
EXAMPLE:AR1208/configure/router rip/interface ethernet0# exit
EXAMPLE:AR1208/configure/router rip# interface wan1
EXAMPLE:AR1208/configure/router rip/interface wan1# exit 3
```

OSPF

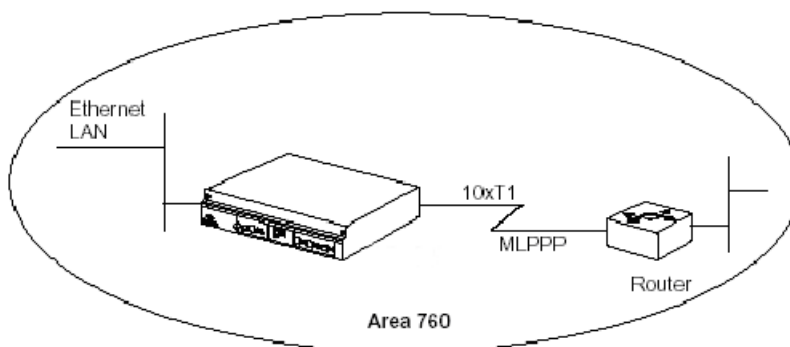

Configuring OSPF between a LAN and a WAN running MLPPP.

```

EXAMPLE:AR1208-T# configure terminal
EXAMPLE:AR1208-T/configure# interface ethernet 0
EXAMPLE:AR1208-T/configure/interface/ethernet 0# ip address 10.10.10.1 24
EXAMPLE:AR1208-T/configure/interface/ethernet 0# exit 2
EXAMPLE:AR1208-T/configure# interface bundle Dallas
EXAMPLE:AR1208-T/configure/interface/bundle Dallas# link ct3 1 1-10
EXAMPLE:AR1208-T/configure/interface/bundle Dallas# encapsulation ppp
EXAMPLE:AR1208-T/configure/interface/bundle Dallas# ip address 20.20.20.1 24
EXAMPLE:AR1208-T/configure/interface/bundle Dallas# exit 2
EXAMPLE:AR1208-T/configure# router routerid 10.10.10.1
EXAMPLE:AR1208-T/configure# router ospf
EXAMPLE:AR1208-T/configure/router/ospf# area 760
EXAMPLE:AR1208-T/configure/router/ospf/area 760# exit
EXAMPLE:AR1208-T/configure/router/ospf# interface Dallas area_id 760
EXAMPLE:AR1208-T/configure/router/ospf/interface Dallas# cost 10
EXAMPLE:AR1208-T/configure/router/ospf/interface Dallas# exit
EXAMPLE:AR1208-T/configure/router/ospf#interface ethernet0 area_id 760
EXAMPLE:AR1208-T/configure/router/ospf/interface ethernet0# cost 10
EXAMPLE:AR1208-T/configure/router/ospf/interface ethernet0# priority 0
EXAMPLE:AR1208-T/configure/router/ospf/interface ethernet0# exit 3

```

BGP4

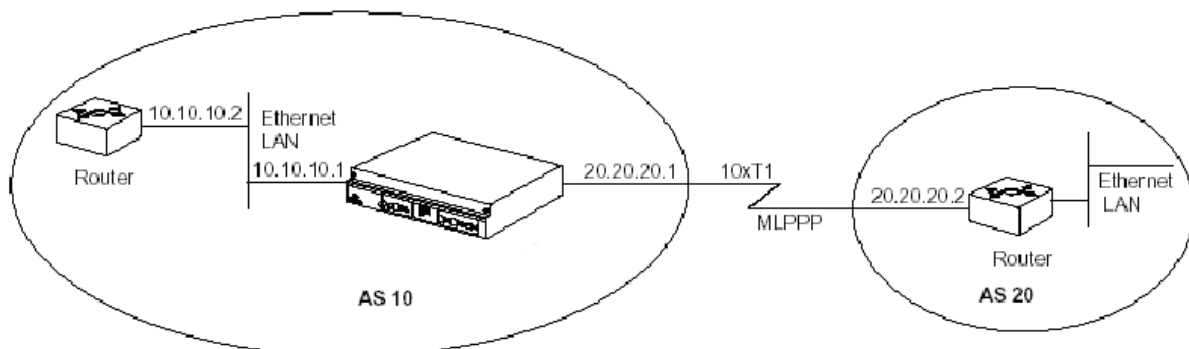

Configuring EBGP between two different autonomous systems.

```

EXAMPLE:AR1208-T/configure# interface bundle Chicago
EXAMPLE:AR1208-T/configure/interface/bundle Chicago# link ct3 1 1-10
EXAMPLE:AR1208-T/configure/interface/bundle Chicago# encapsulation ppp
EXAMPLE:AR1208-T/configure/interface/bundle Chicago# ip address 20.20.20.1 24
EXAMPLE:AR1208-T/configure/interface/bundle Chicago# exit
EXAMPLE:AR1208-T/configure# router bgp 10
EXAMPLE:AR1208-T/configure/router/bgp 10# neighbor 20.20.20.2 20
EXAMPLE:AR1208-T/configure/router/bgp 10/neighbor 20.20.20.2 20# exit 3

```

Configuring IBGP between two neighbors in the same autonomous system.

```

EXAMPLE:AR1208-T/configure# interface ethernet 0
EXAMPLE:AR1208-T/configure/interface/ethernet 0# ip address 10.10.10.1 24
EXAMPLE:AR1208-T/configure/interface/ethernet 0# exit
EXAMPLE:AR1208-T/configure# router bgp 10
EXAMPLE:AR1208-T/configure/router/bgp 10# neighbor 10.10.10.2 10
EXAMPLE:AR1208-T/configure/router/bgp 10# neighbor 10.10.10.2 10# exit 3
Redistributing static and connected routes.
EXAMPLE:AR1208-T/configure# ip route 9.9.0.0 255.255.0.0 10.10.10.10
EXAMPLE:AR1208-T/configure# router bgp 10
EXAMPLE:AR1208-T/configure/router/bgp 10# redistribute static
EXAMPLE:AR1208-T/configure/router/bgp 10# redistribute connected
EXAMPLE:AR1208-T/configure/router/bgp 10# exit 2
    
```

NxE1/MFR Bundle

```

EXAMPLE:AR1208-E# configure term
EXAMPLE:AR1208-E/configure# interface bundle Madrid
EXAMPLE:AR1208-E/configure/interface/bundle Madrid# link e1 3-4
EXAMPLE:AR1208-E/configure/interface/bundle Madrid# encapsulation fr
EXAMPLE:AR1208-E/configure/interface/bundle Madrid# fr
EXAMPLE:AR1208-E/configure/interface/bundle Madrid/fr# intf_type dce
EXAMPLE:AR1208-E/configure/interface/bundle Madrid/fr# lmi
EXAMPLE:AR1208-E/configure/interface/bundle Madrid/fr/lmi# keepalive 12
EXAMPLE:AR1208-E/configure/interface/bundle Madrid/fr/lmi# exit
EXAMPLE:AR1208-E/configure/interface/bundle Madrid/fr# pvc 16
EXAMPLE:AR1208-E/configure/interface/bundle Madrid/fr/pvc 16# shaping cir 1920000
EXAMPLE:AR1208-E/configure/interface/bundle Madrid/fr/pvc 16# exit
EXAMPLE:AR1208-E/configure/interface/bundle Madrid/fr# enable interface
EXAMPLE:AR1208-E/configure/interface/bundle Madrid/fr# exit 4
    
```

Fractional E1/Cisco-compatible HDLC Bundle

```

EXAMPLE:AR1208-E# configure term
EXAMPLE:AR1208-E/configure# interface bundle London
EXAMPLE:AR1208-E/configure/interface/bundle London# link e1 3:1-6
EXAMPLE:AR1208-E/configure/interface/bundle London# encapsulation hdlc
EXAMPLE:AR1208-E/configure/interface/bundle London# hdlc keepalive 20
EXAMPLE:AR1208-E/configure/interface/bundle London# ip address 192.168.2.1 255.255.255.0
EXAMPLE:AR1208-E/configure/interface/bundle London# exit 3
    
```

Saving Configurations

Use the following command to save new configurations to system memory.

```
EXAMPLE:AR1208# write mem
```

Use the following command to save new configurations to a network host for archiving and back-up purposes. Identify the host name or IP address, the host directory the file is being transferred to, and the new name as follows.

```
EXAMPLE:AR1208# save network 10.1.100.149 /maindir/config01.txt
```

When saving to a network host, the host directory and file name must pre-exist.

LEDs

The Foundry system front-panel LEDs indicate real-time unit status. The following table provides information about how to interpret the various LED states. For more detailed LED descriptions, refer to the Foundry *Installation Guide: Domestic Products*.

LED State	Description
Off	Indicates an absence of power, a deselected function, or an out-of-service link
Green	Indicates either an engaged or a properly functioning feature
Yellow	Indicates an out-of-service test or a failed DC converter (Power LED)
Green or yellow with blinking red	Same as above conditions for green and yellow, but one or more of the following errors have been detected on a T1 port: Framing bit errors CRC-6 errors (in ESF mode) Line code violations
Red	Indicates either an error, an alarm, or a loss of signal

